

LAMP MEMORY INTERCOM SYSTEM

MODELS:	NEM-10(TYPE C), *NEM-10A(TYPE C)	(10-call master)
	NEM-20(TYPE C), *NEM-20A(TYPE C)	(20-call master)
	NEM-30(TYPE C), *NEM-30A(TYPE C)	(30-call master)
	NEM-40(TYPE C), *NEM-40A(TYPE C)	(40-call master)
		*with handset

INSTRUCTIONS All the information contained in this INSTRUCTIONS is for NEM-, NEM-A (TYPE C) version.

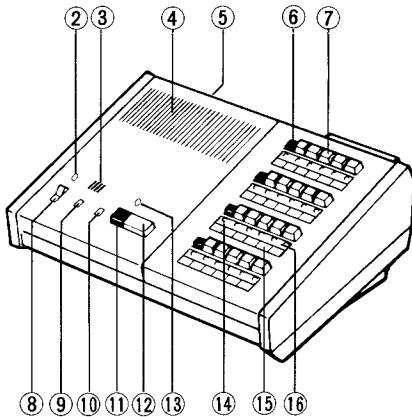

NEM-20

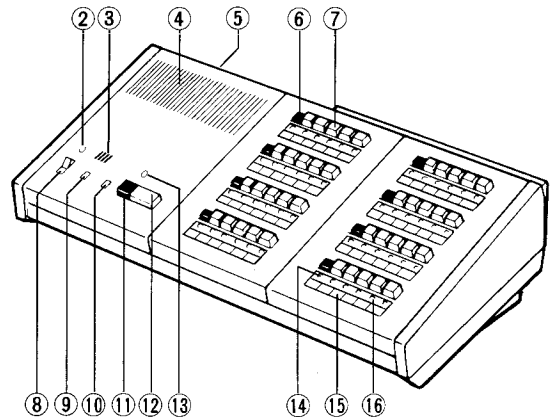

NEM-40

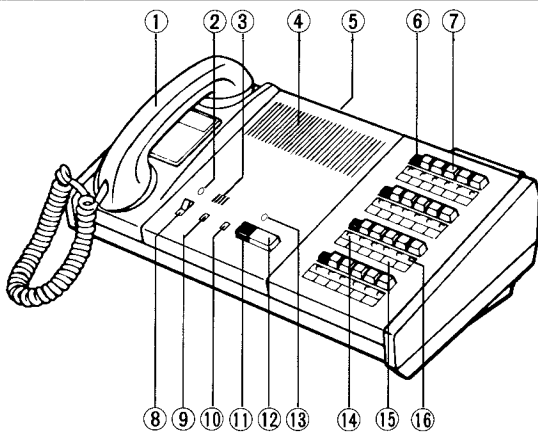

NEM-20A

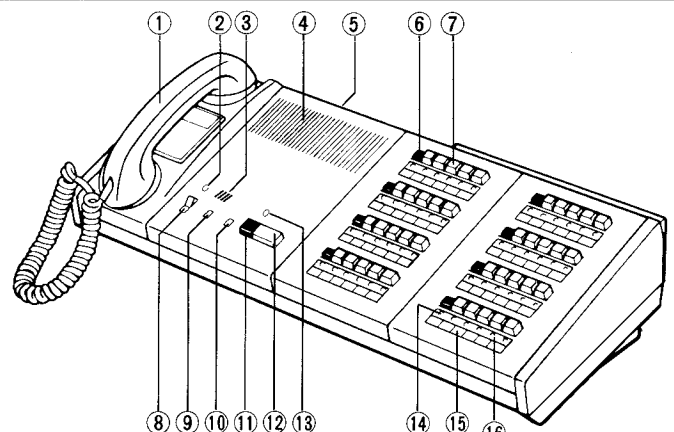

NEM-40A

NOTE; The appearance of NEM-10, NEM-30, NEM-10A & NEM-30A is the same as each of NEM-20, NEM-40, NEM-20A & NEM-40A, except the number of selector switch bank.

1 NAMES AND FUNCTIONS

- | | |
|---------------------------------|---|
| ① Handset (only for NEM-A type) | ⑨ Volume control for receive volume |
| ② Power LED | ⑩ Volume control for call tone |
| ③ Microphone | ⑪ ALL CALL button |
| ④ Speaker | ⑫ TALK button |
| ⑤ Pre-setting volume controls | ⑬ Transmit monitor LED (Occupied LED when NEW-5 is connected) |
| ⑥ OFF button | ⑭ Selection indicator LED |
| ⑦ Station selector button | ⑮ Directory card |
| ⑧ Power switch | ⑯ Call annunciator LED |

2

FEATURES

- * Communication can be either voice-activated, using handset, or alternate by TALK button operation (NEM-A type).
- * Simple wiring . . . two wires (1 common + 1 individual) per sub.
- * Employs crosstalk-eliminating circuits, by which communication is least affected by wiring conditions, yet ensures sufficient speech volume.
- * Call-in from a sub is annunciated by electronic tone and LED, both remain until master replies.
- * Pre-tone at a sub indicates a call from master, or a call is being answered.
- * All call to make an announcement to all the subs simultaneously or selectively up to 10 subs.
- * Call extension speaker to receive the call tone from sub at elsewhere.
- * A variety of subs and accessories.
 1. NEW-5, parallel-call adaptor allows calling two masters from a sub simultaneously. One NEW-5 handle max. 5 subs. Max. 8 NEW-5 per system (NEM-40/40A).
 2. NBJ-/NBJ-B night-switcher, so as to switch a master on duty for night shift, etc.
 3. NBR-7AS pull cord moisture-resistant call switch designed for use in bathroom.
 4. NB-U, BGM adaptor for distributing background music to subs.

3

BEFORE YOU OPERATE AND INSTALL THE EQUIPMENT — Prohibitions and precautions —

* OPERATION;

1. When the handset is picked up, the Talk-Listen operation will be automatic voice activation. By speaking into the handset, the communication will be transmitting mode, and when quits speaking, it will become to a receiving mode.

* INSTALLATION:

1. Lay out your system in advance. Determine the locations of each sub station and wire to each. Only two conductors are required per sub station.
Either of the following methods may be used;
 - (1) Two wires from each sub to the master station terminal block.
 - (2) Two wires from each sub to a local junction box, then multi-conductor cable to master station terminal block.
 - (3) Use a multi-conductor cable looped thru each sub.When multi-conductor cable is not used, be sure to run each cable in the same conduit, so as to make each station line as near the common line as possible.
2. DO NOT CONNECT ANY TERMINAL ON ANY UNIT TO AC POWER LINES.
3. BE SURE TO UNPLUG POWER SUPPLY FROM AC OUTLET BEFORE YOU OPEN THE UNIT OR MAKE WIRING CONNECTIONS.
4. Select an installation location that;
 - (1) is free from dust, (2) is vibration-free, (3) is not near inflammable or chemical products (NONE OF THE SYSTEM COMPONENTS IS EXPLOSION-PROOF TYPE), (4) is not near heating or air conditioning equipment, (5) does not have direct sunlight, (6) does not have temperature/humidity extremes.
5. Avoid pinching a wire(s) by doors and/or furnitures.
6. NBR-7AS is not water-resistant type. Avoid location close to bath tub where NBR-7AS is possible to receiver shower.

* UNIT SELECTION:

1. NA-AN and NAR-6N include diodes for privacy function which affects seriously on the sound quality of background music. Use non-privacy sub stations, NA-A or NA-NE, or release PRIVACY switch on NA-AN and/or NAR-6N, when background music is distributed.
2. For a system of up to 20 sub stations, install one PS-24C power supply.
For a system of more than 20 sub stations, install one PS-24N instead of using two PS-24C power supplies.
3. NEW-5 parallel-call adaptor works only with NEM/NEM-A (Type C) version.
In a system with NEW-5, NB-U, BGM adaptor can not be used.

* MAINTENANCE;

1. Clean your intercom equipment with a soft cloth dampened with neutral household cleanser. Never use thinner nor benzine, etc.

4

SYSTEM COMPONENTS

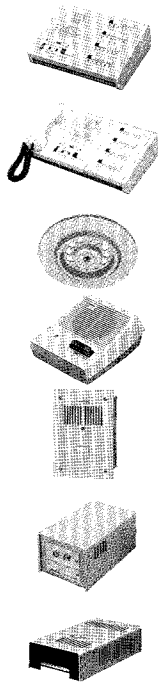

MODELS	DESCRIPTION	QTY	REMARKS
NEM-10 NEM-20 NEM-30 NEM-40 NEM-10A NEM-20A NEM-30A NEM-40A	10-call master. — do —, 20-call. — do —, 30-call. — do —, 40-call. 10-call master with handset. — do —, 20-call. — do —, 30-call. — do —, 40-call.	1 per system (master selective system).	*Can either be wall-mounted or placed on desk.
NB-L	Ceiling mount sub.	Max. 40 pcs (in NEM-40 or NEM-40A system).	*Requires a separate call button to call master. Install with or without NBZ-M frame.
NA-A NA-AN	1-call sub. Desk/Wall. — do —, privacy type.		
NA-NE	Flush-mount sub, 1-call.		*Built-in back box is provided.
PS-24C	UL & CSA LISTED power supply.	One per system.	*Use for less than 20-station system.
PS-24N	Power supply. DC 24V, 2A.	One per system.	*Use for more than 20-station system.

ACCESSORIES;

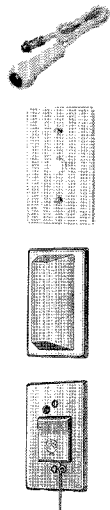

NBY-1A NBR-8A	Receptacle for NBR-8A. Hand-held call button with plug.	One for each NBR-8A.	
NAR-6A NAR-6N	Call button. — do —, privacy type.		*NAR-6A: with black button.
NAR-2A	Reset button.	One for each corridor lamp.	*NAR-2A: with white button.
NAR-3 NBY-4A NBR-7AS	Round corridor lamp. Rectangular corridor lamp. Moisture-resistant call switch w/pull cord.		*NAR-3, not available in U.S.A. *Up to three NBR-7AS can be installed per line.
NBJ-20 NBJ-40 NBJ-20B NBJ-40B	Night-switcher for NEM-10, 20. — do — for NEM-30, 40. — do — for NEM-10A, -20A. — do — for NEM-30A, -40A.	One (or more) per system	*Master unit mounts on the night-switcher. See page 9 for details.
IER-2	Call extension speaker.	One per master.	*Call tone only.
NB-U	BGM adaptor.	One per system.	
PG-10A NEW-5	— do — UL/CSA LISTED. Parallel-call adaptor.	One per system. One per 5 subs.	*Can be powered by a single PS-12C power supply.

MOUNTING ACCESSORIES;

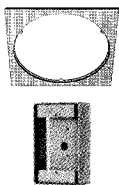

NBZ-M NP-W	Square frame for NB-L flush-mounting to ceiling. Surface mount box.	One for NB-L One for each accessory.	*NB-L can be flush-mounted without using NBZ-M frame. *Such accessories as NBY-1A, NAR-6A, NAR-6N, NAR-2A, NBY-4A and NBR-7AS can be mounted on NP-W.
---------------	--	---	--

5

INSTALLATION

(1) ACTUAL TERMINAL LOCATION

The master station terminal block is located on back of the cabinet.

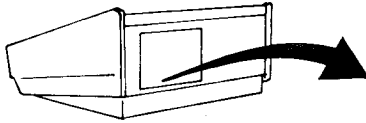

NEM
NEM-A

(**) [S], [E] for NEM-10/20, NEM-10A/20A

- [1] ~ [40] } Connect to sub station.
 - [S], [S] (**) : Connect to call extension IER-2.
 - [Q], [H], [Y], [E] : Connect to NEW-5 adaptor.
 - [X1] ~ [X8] : Unused (to be required for connecting add-on selector).
 - [B] ~ [Y] (*) } Connect to NB-U, BGM adaptor.
 - [V1] ~ [V4] }
 - [A1] ~ [A4] }
- (*) same terminal.
(NB-U and NEW-5 can not be co-used in a system).

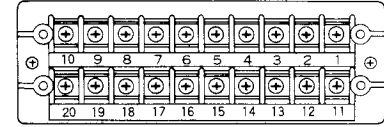
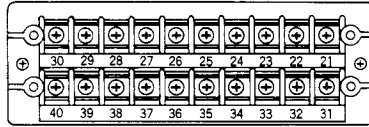
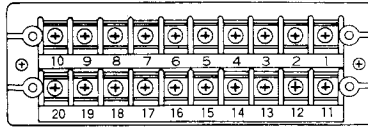
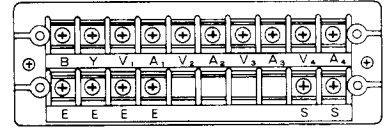
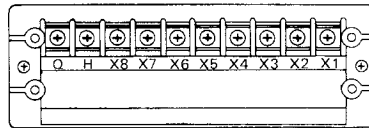
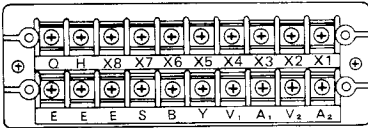

NEM-10/20 NEM-10A/20A

NEM-30/40 NEM-30A/40A

WIRE AND TERMINAL IDENTIFICATION

When a corridor lamp is installed, remove GREEN wire from BLACK wire and leave GREEN wire unused on NB-L and NA-NE, and remove jumper between [D] and [E] on NA-A and NA-AN.

NB-L

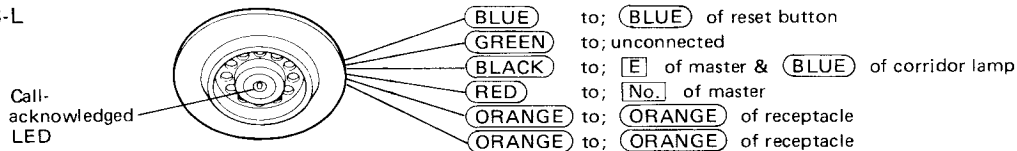

NA-A (illustration)
NA-AN

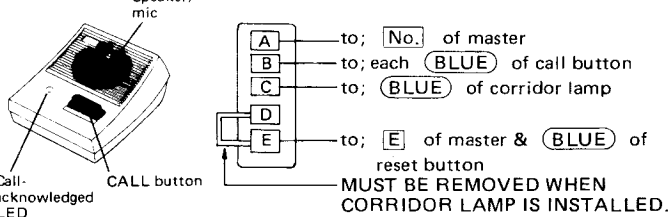

NA-NE

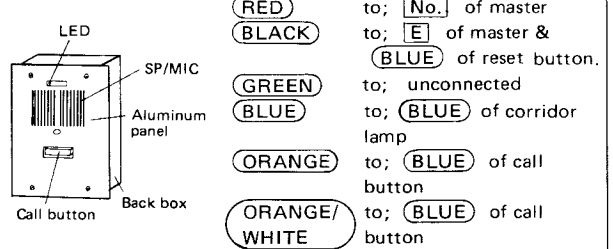

NAR-3

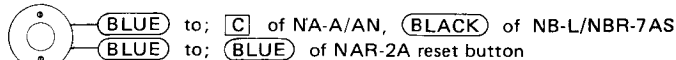

NBY-4A

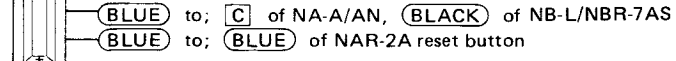

NAR-2A (WHITE BUTTON)

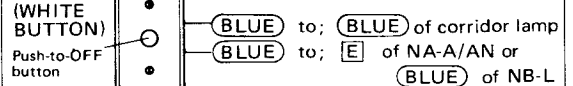

NBY-1A NAR-6A

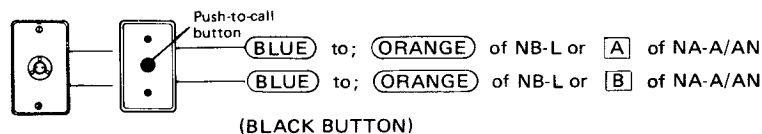

NBR-7AS

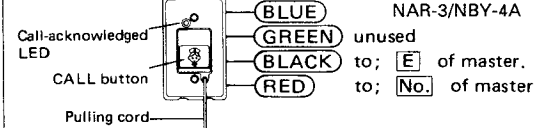

NAR-6N NAR-6N(S) must be installed via NAR-6N(P) in order to avoid voice distortion in privacy mode.

NAR-6N(S)
switch unit.

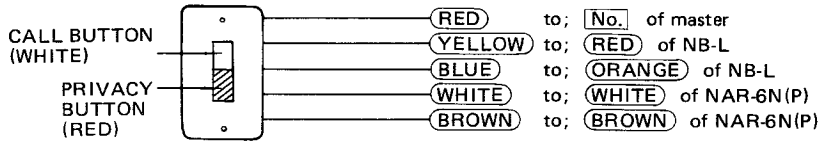

NAR-6N(P),
privacy filter.

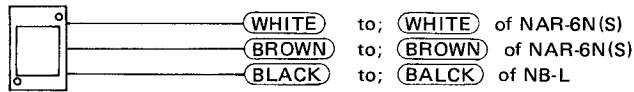

(2) WALL MOUNTING

NEM, NEM-A master stations;

For wall-mounting, install sub chassis upside down.

When a gang box is provided, use sub plate as shown in illustration.

NOTES; * Sub chassis must be ALWAYS used for heat radiation.

* For NEM-A types, attach the supplied handset cradle.

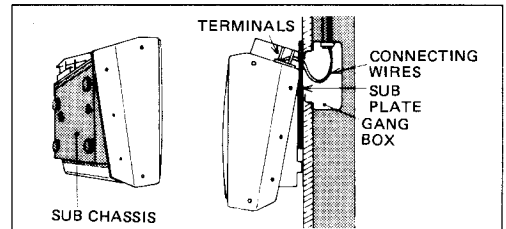

Sub stations;

●NA-A, NA-AN

Attach bracket to wall or single-gang box with the supplied screws.
Mount the station on the bracket.

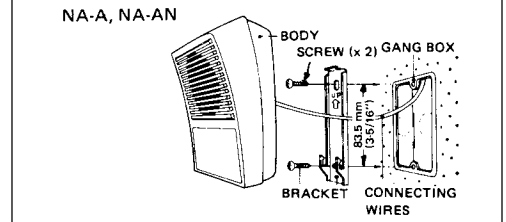

●NA-NE

Remove four screws and separate back box from front panel.
Using a sharp knife or screwdriver, knock out a hole in back box to pass wiring cable at either of three points most convenient.
Mount the back box into wall with supplied two screws.
Connect wires and reattach front panel to the back box.

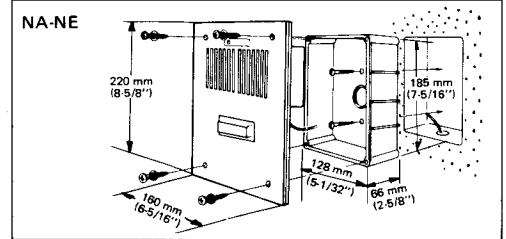

●NB-L + NBZ-M

Open a hole of 150 mm (5-7/8") diameter in the ceiling.

Put a holder into the hole like a bridge.

Attach square frame (NBZ-M) to speaker from the back.

Hang the speaker by hooking to either spring, and connect wires.

After wired, hook to the other spring, so that the speaker fits properly in the hole.

NOTE; NB-L can be flush-mounted without using NBZ-M frame.

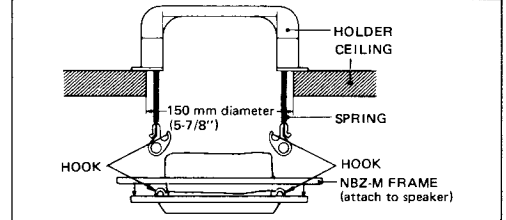

NAR-3

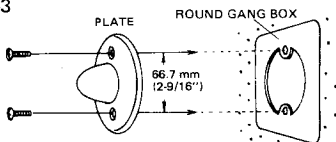

Mount the lamp to the round gang box with supplied screws (4 x 30 mm).

NBY-1A

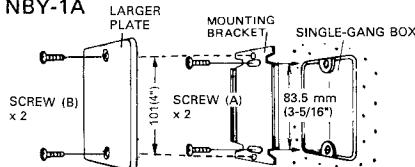

Attach bracket to single-gang box with supplied screws (A) (4 x 40 mm).
Attach the unit to bracket with supplied screws (B) (3.5 x 10 mm).

NAR-2A, NAR-6A & NBR-7AS

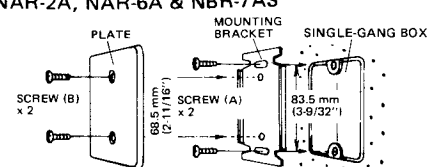

NBY-4A

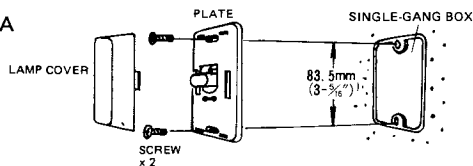

Separate lamp cover from plate by pushing sides of cover.
Attach the plate to single-gang box with supplied screws (4 x 30 mm), and reattach cover.

NP-W

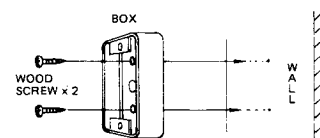

Mount the box to wall with the supplied wood screws.

6

WIRING DIAGRAM

(1) NEM-A SYSTEM WITH SUBS WITH ACCESSORIES FULLY EQUIPPED

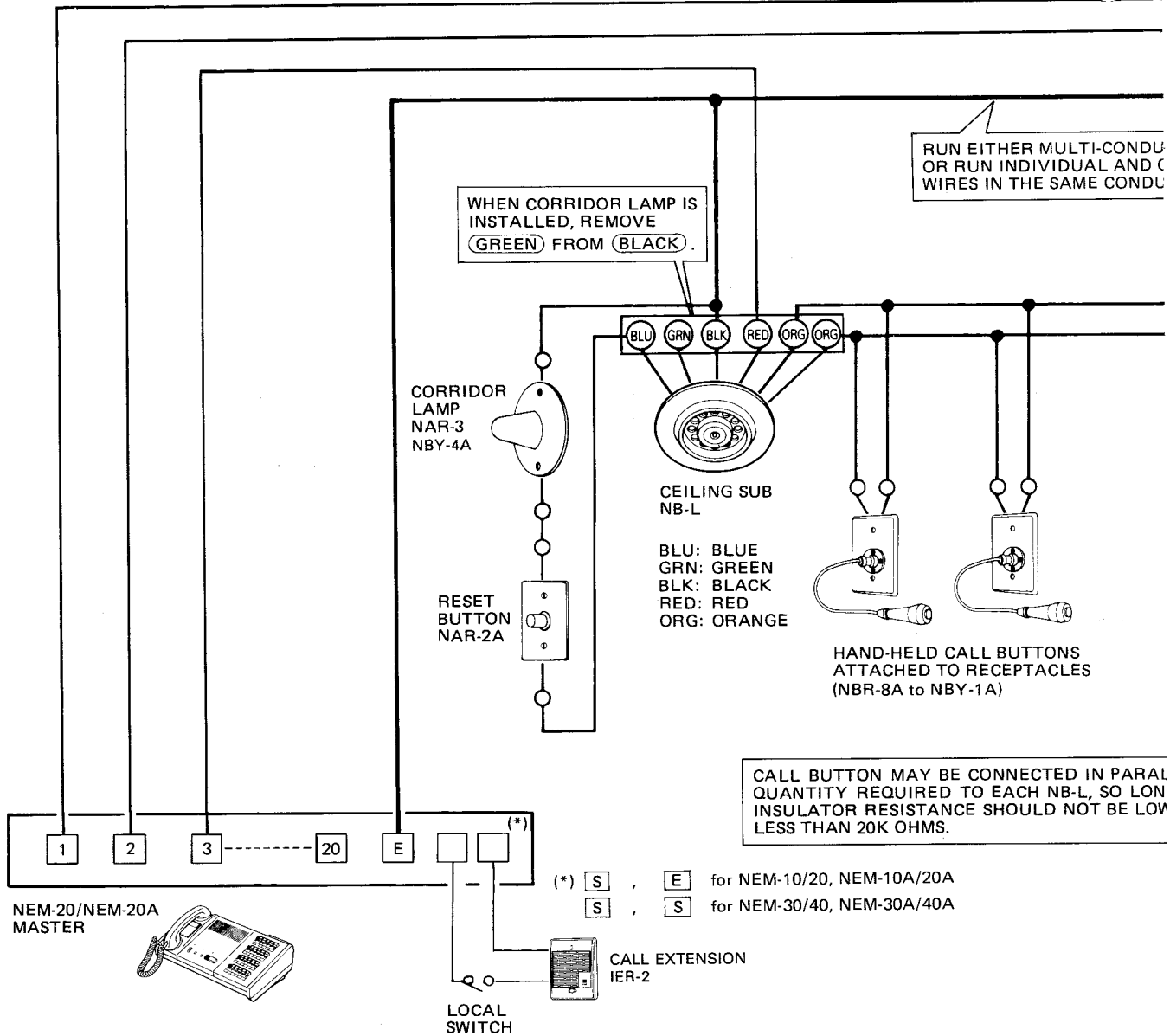

NB-L	Power supply PS-24C or PS-24N
<p>GREEN WIRE</p> <p>Cut out when corridor lamp is connected.</p> <p>CONNECTOR (MALE)</p> <p>Attach connecting wires to female connector and attach to male connector on NB-L.</p>	<p>Master station has DC24V input terminals on back of the unit. Connect a pair of wires from PS-24C or PS-24N power supply to +, - terminals on master as shown. Observe polarity.</p> <p>NEM-10, NEM-20 NEM-10A, NEM-20A</p> <p>PS-24C</p> <p>NEM-30, NEM-40 NEM-30A, NEM-40A</p> <p>PS-24N</p> <p>NOTE: For a system of more than 20 stations, use PS-24N instead of two PS-24C. On PS-24N G terminal, be sure to take earth to avoid noise, which could occur while communicating with sub.</p>

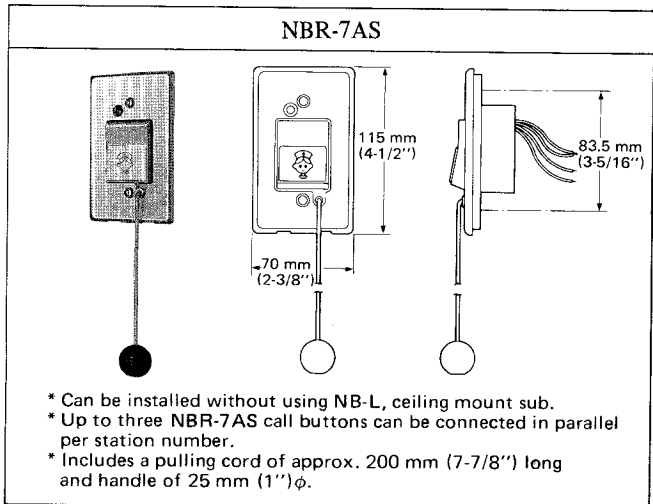
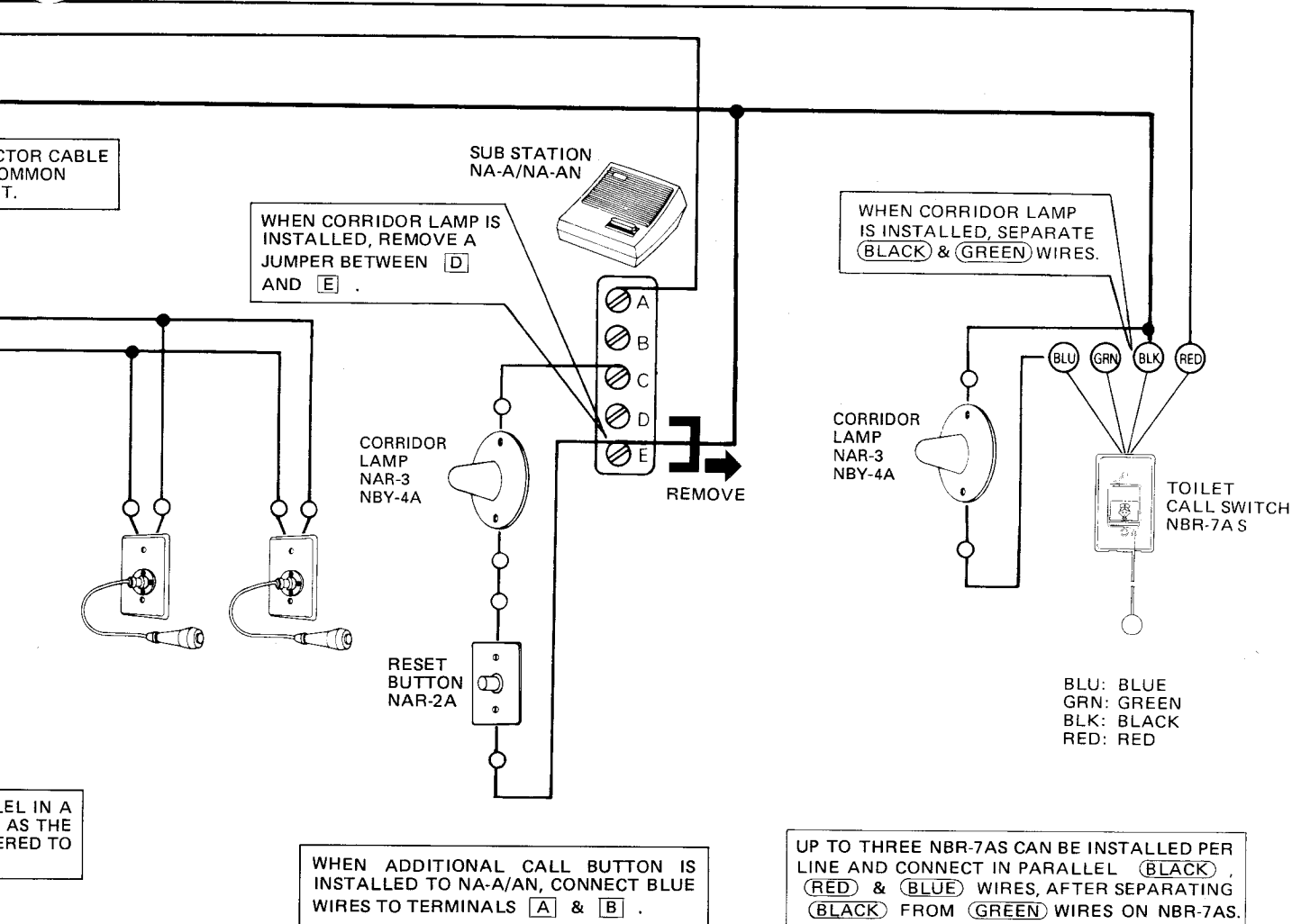

(2) NEM-10/NEM-10A SYSTEM WITH SUB STATIONS CONNECTED TO FULL CAPACITY

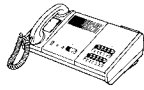

MASTER STATION NEM-10/NEM-10A

(*) S , E for NEM-10/20, NEM-10A/20A
 S , S for NEM-30/40, NEM-30A/40A

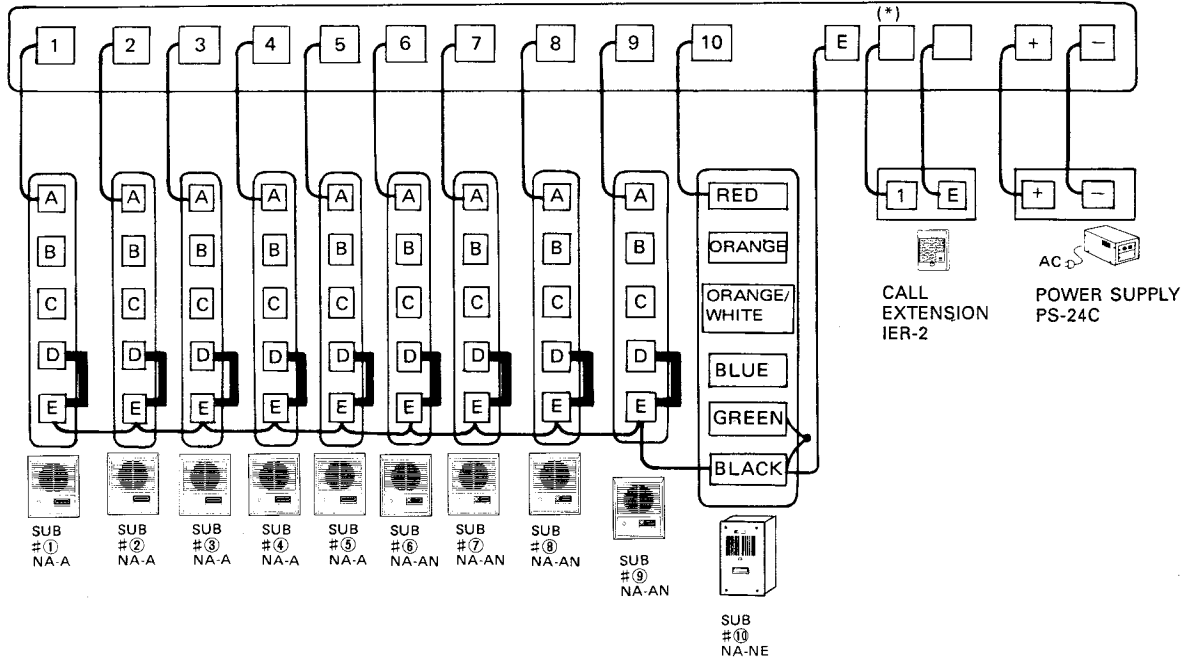

The diagram shows sub stations NA-A, NA-AN or NA-NE, each with call button equipped, are connected to master station full capacity. Do not remove a jumper between **D** & **E** on NA-A/NA-AN or **GREEN** & **BLACK** wires on NA-NE.

(3) NEM-30/NEM-30A SYSTEM WITH BACKGROUND MUSIC, USING NB-U

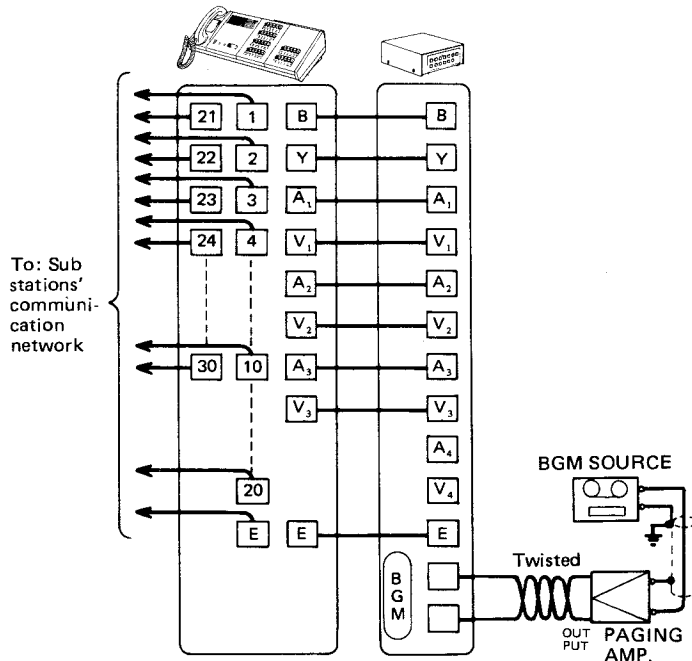

NOTE;
 Remove a jumper between **A₁** and **V₁** , **A₂** and **V₂**
A₃ and **V₃** on master station.

The diagram shows wiring connection for distributing background music thru all sub stations. One NB-U, BGM adaptor and one paging amplifier PG-10A are required, as well as BGM source. Background music will mute automatically throughout the system during calling and communication. Background music can not be turned off at sub station.

(4) NEM/NEM-A SYSTEM WITH NEW-5 PARALLEL-CALL ADAPTOR;

The following diagram illustrates a total of 35 NA-A subs connected to NEW-5 adaptors Nos.1 ~ 7, can call two masters simultaneously.

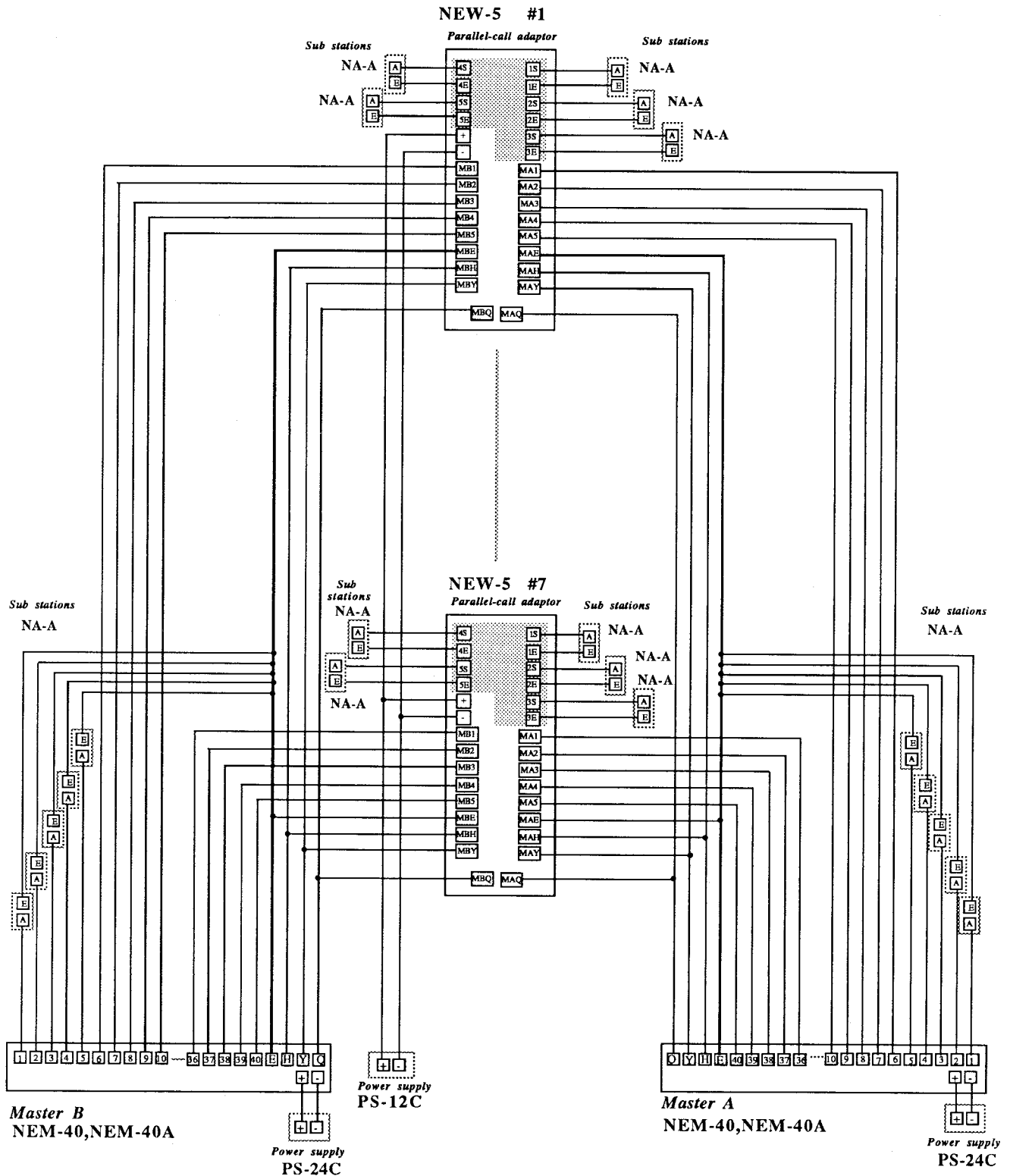

7

OPERATIONS

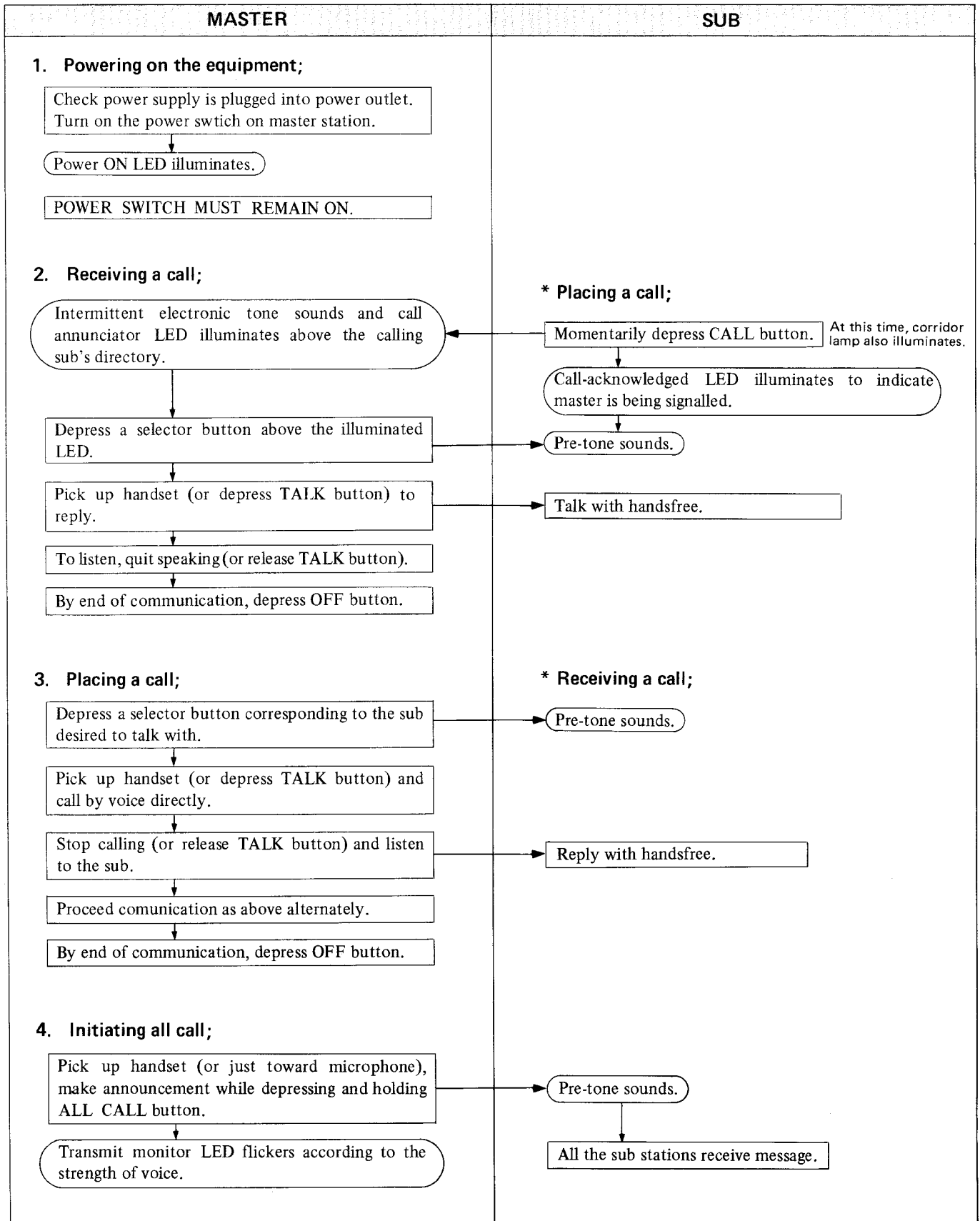

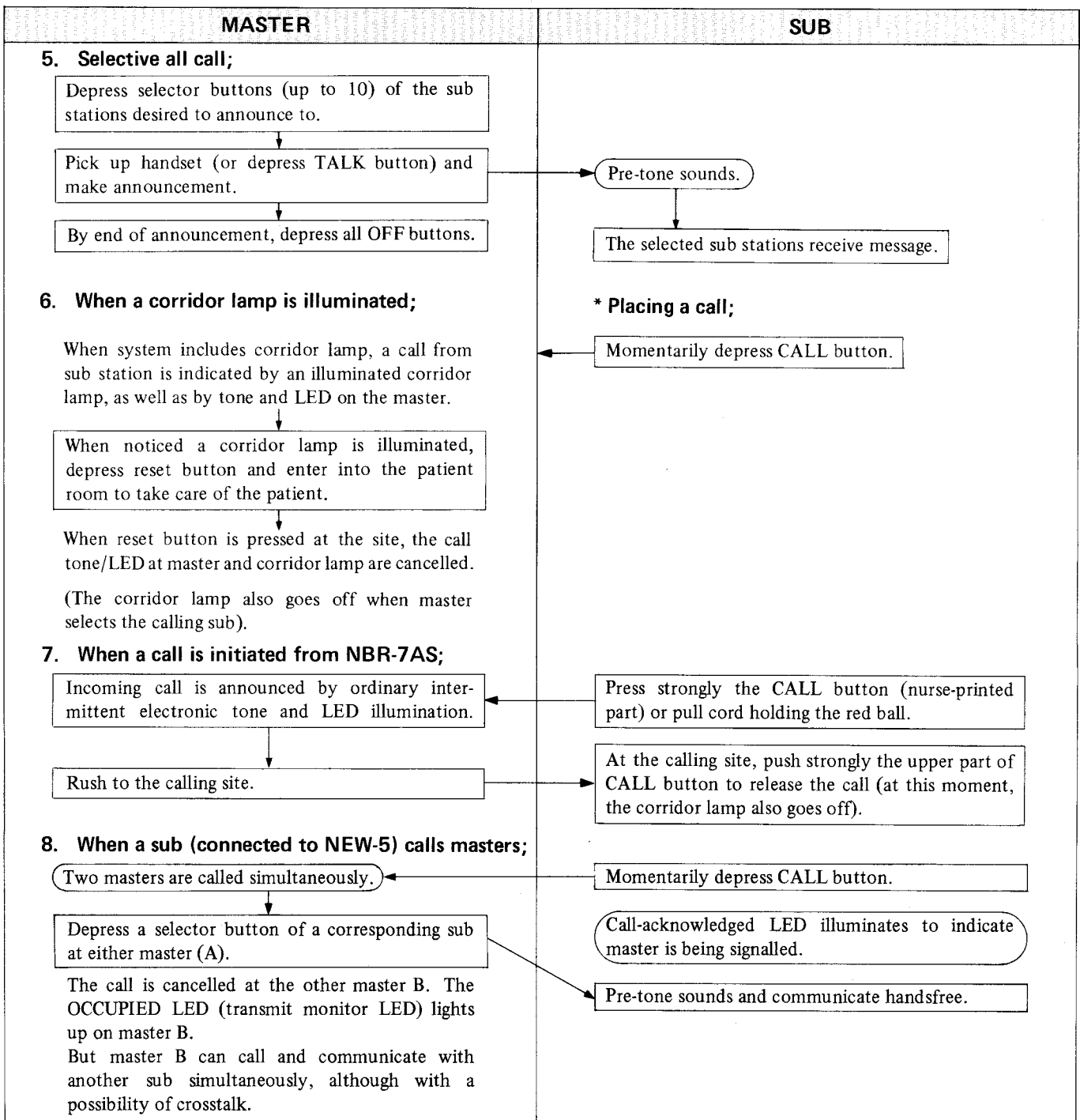

ADJUSTING VOLUME CONTROLS

Master station has pre-setting volume controls located on back of the unit and daily-use volume switches located on front panel, each allowing individual adjustment of reception and call tone to desired level. When adjusting pre-setting volume control for reception, be sure to set the volume switch on front panel at MIDDLE position.

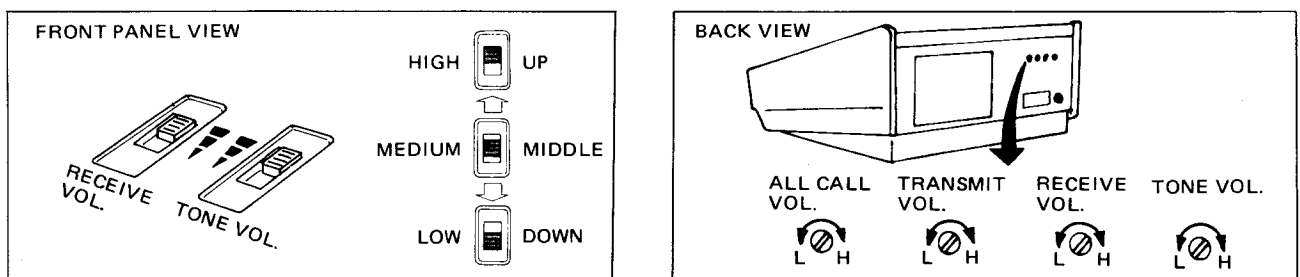

8

SPECIFICATIONS

- * Power source; DC 24V. Use PS-24C or PS-24N power supply.
Use PS-24N power supply for a system of more than 20 sub stations or if master should receive calls simultaneously from five subs or more, each of which corridor lamp is attached to.
- * Power consumption; NEM-10, -20, -10A, -20A: Max. 24W. 2W in standby mode.
NEM-30, -40, -30A, -40A: Max. 45W. 4W in standby mode.
- * Communication output; 500 mW maximum at master (with receive volume control on master)
500 mW maximum at sub (with transmit volume control on master).
- * All call output; 6 W in a system of up to 20 sub-stations.
12 W in a system of more than 20 sub stations.
3 W per 10 sub stations in a selective all call.
- * Type of communication; Voice-activated, using handset (NEM-A types) or press-to-talk loudspeaking communication.
- * Calling; Master station; Called by tone and LED (remains until answered).
Sub station; Called by voice from master, after pre-tone sounds.
- * Wiring; Two wires per sub (1 common + 1 individual).
- * Wiring distance; Select the proper wire gauge from the chart below to meet your requirements;

AWG	22 AWG	20 AWG	18 AWG
DISTANCE	420'	650'	1000'

DIAMETER	0.65 mm	0.8 mm	1.0 mm
DISTANCE	130 m	200 m	300 m

*Dimensions & weight;

MODEL	WIDTH	HEIGHT	DEPTH	WEIGHT
NEM-10	346 (13-5/8")	140 (5-1/2")	260 (10-1/4")	Approx. 4.5 kg (9.92 lbs)
NEM-20	346 (13-5/8")	140 (5-1/2")	260 (10-1/4")	Approx. 5.0 kg (11.02 lbs)
NEM-30	496 (19-1/2")	140 (5-1/2")	260 (10-1/4")	Approx. 6.5 kg (14.33 lbs)
NEM-40	496 (19-1/2")	140 (5-1/2")	260 (10-1/4")	Approx. 7.0 kg (15.43 lbs)
NEM-10A	446 (17-9/16")	176 (6-15/16")	260 (10-1/4")	Approx. 5.5 kg (12.13 lbs)
NEM-20A	446 (17-9/16")	176 (6-15/16")	260 (10-1/4")	Approx. 6.0 kg (13.23 lbs)
NEM-30A	596 (23-7/16")	176 (6-15/16")	260 (10-1/4")	Approx. 7.5 kg (16.53 lbs)
NEM-40A	596 (23-7/16")	176 (6-15/16")	260 (10-1/4")	Approx. 8.0 kg (17.64 lbs)

WARRANTY

Aiphone warrants its products to be free from defects of material and workmanship under normal use and service for a period of one year after delivery to the ultimate user and will repair free of charge or replace at no charge, should it become defective upon which examination shall disclose to be defective and under warranty. Aiphone reserves unto itself the sole right to make the final decision whether there is a defect in materials and/or workmanship; and whether or not the product is within the warranty.

This warranty shall not apply to any Aiphone product which has been subject to misuse, neglect, accident, or to use in violation of instructions furnished, nor extended to units which have been repaired or altered outside of the factory.

This warranty does not cover batteries or damage caused by batteries used in connection with the product.

This warranty covers bench repairs only, and any repairs must be made at the shop or place designated in writing by Aiphone. Aiphone will not be responsible for any costs incurred involving on site service calls.

Aiphone Co., Ltd., Nagoya, Japan
Aiphone Corporation, Bellevue, Washington



Printed in Japan (E)

NEM/NEM-A(TYPE C)-(E) 0790D